

JUST

BY SCAGNELLATO & FERRARESE





Ciò che distingue JUST è il sedile ribaltabile, che consente di ottimizzare lo spazio sia nel luogo di utilizzo della sedia, sia nel caso la si debba stoccare. JUST utilizza una semplice struttura a cavalletto, da cui si ottiene la versione a quattro gambe della sedia che risulta ideale per spazi come sale d'attesa, aree meeting ed uffici. Lo stesso fusto può essere poi utilizzato su ruote, nel caso sia richiesto l'elemento della mobilità della sedia. La disponibilità tra gli accessori di una tavoletta antipanico con dimensioni importanti, così come la possibilità di montare la seduta su barra componendo panche da due a quattro posti, ampliano ulteriormente gli ambiti di impiego immaginabili per il modello JUST.

JUST stands out for its folding seat, which enables to optimize the space both in the site where the chair is used and where it is stocked. Based on a simple trestle structure, JUST is available on four legs and suitable for waiting areas, meeting areas and offices. The same frame can be placed on castors if the portability is specifically required.

The availability of other accessories as the xl antipanic writing tablet and the possibility to assemble the seat on a beam, composing 2 to 4 places benches, allow us to imagine more ways of using the JUST collection.

Lo que distingue Just de las otras es su asiento abatible, que permite de optimizar el espacio en su lugar de empleo y también en el caso de su almacenamiento. Just utiliza una sencilla estructura a compás con la cual se crean dos configuraciones: la de cuatro patas por lugares como salas de espera y espacios comunes y la misma sobre rodajas para utilizarse adonde la movilidad de la silla es un elemento requerido.

Una serie de accesorios, entre cuales la abundante paleta con mecanismo anti-pánico, amplían su posibilidades de uso. Ensamblada como bancada se pueden componer asientos de entre dos y cuatro plazas, que introducen la posibilidad de empleo para sala de conferencias y conciertos.

















JUST nella versione senza braccioli si aggancia senza ausilio di alcun componente aggiuntivo, usando l'apposito sistema già integrato nella sedia stessa.

JUST in the version without armrests hangs without any additional component, using the special system already integrated in the chair itself.

JUST sin brazos se enganche sin la ayuda de ningún componente adicional, utilizando el sistema especial ya integrado en la misma silla.















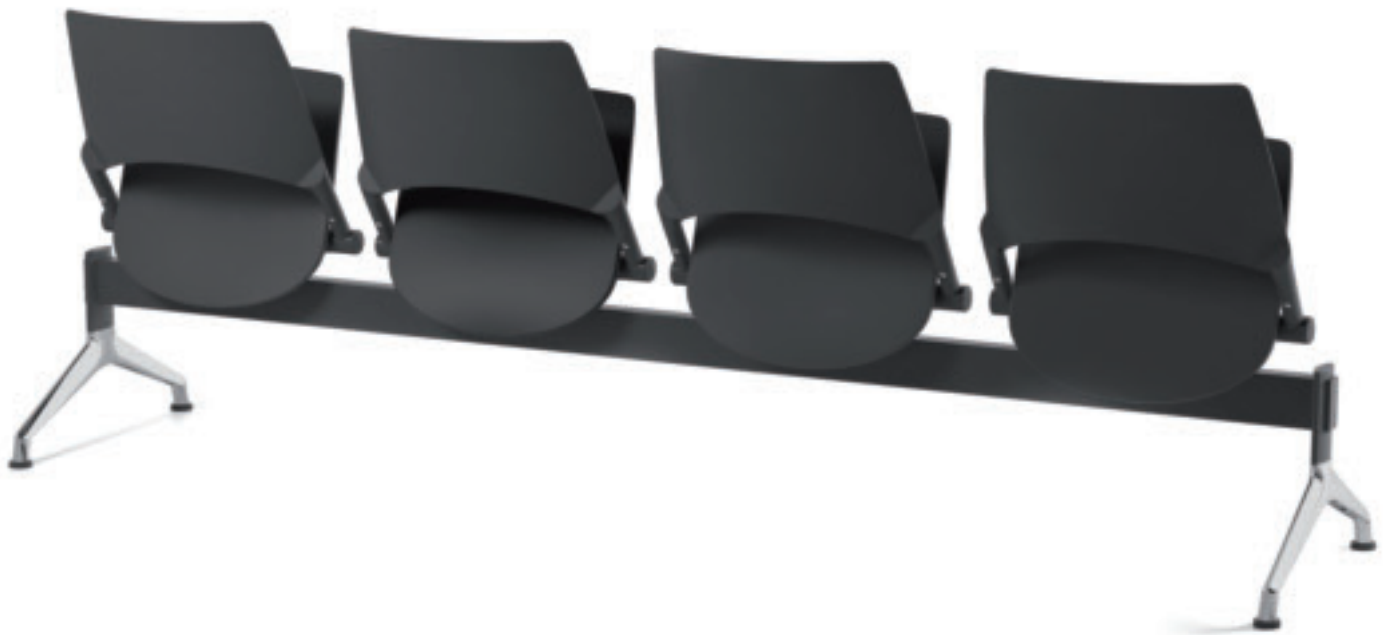

COLORI PLASTICHE | PLASTIC COLORS | COLORES DE PLÁSTICO

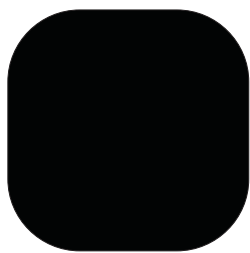

NERO / BLACK / NEGRO
RAL 9005

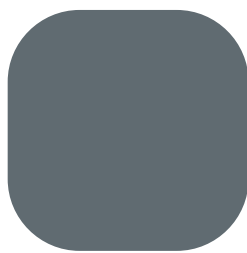

GRIGIO / GREY / GRIS
RAL 7045

COLORI STRUTTURE | METAL FRAMES COLORS | ACABADOS DE ESTRUCTURAS



NERO / BLACK / NEGRO
RAL 9005



GRIGIO / GREY / GRIS
RAL 7045



CROMO / CHROME / CROMADO

DIMENSIONI | DIMENSIONS | MEDIDAS

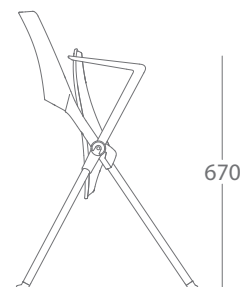
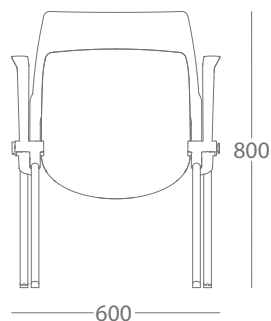
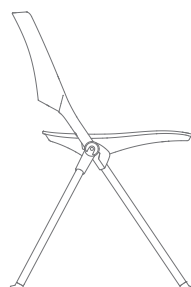
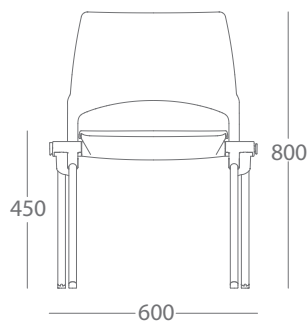

I colori campione presenti in queste pagine possono essere validi come riferimento indicativo. Per avere un riscontro preciso consigliamo di consultare i campioni colore reali.

The colours are only to be considered as an indication of the real colour. To get a precise feedback you should consult the real colour samples.

Los colores de la muestra en estas páginas pueden ser valiosas como guía de referencia. Para obtener una respuesta precisa deben consultar a las muestras reales de color.

JUST

componenti kit - kit components - componentes kit

SCHIENALI | BACKRESTS | RESPALDOS



JUST/24G

schienale Just in plastica grigio | Just grey plastic backrest | respaldo gris Just



JUST/24N

schienale Just in plastica nero | Just black plastic backrest | respaldo negro Just



SEDILI | SEATS | ASIENTOS

VERSIONE PLASTICA | PLASTIC VERSION | VERSIONS DE PLASTICO



JUST/25G

sedile Just in plastica grigio | Just grey plastic seat | asiento gris Just



JUST/25N

sedile Just in plastica nero | Just black plastic seat | asiento negro Just



VERSIONE PER TAPPEZZERIA | VERSION FOR UPHOLSTERY | VERSION PARA TAPIZAR



JUST/03

interno sedile Just da tappezzare | Just inner seat for upholstery | asiento para tapizar Just



ESTERNO SEDILE | OUTER SEAT | CUBRE ASIENTO



JUST/04

esterno sedile Just nero | Just black outer seat | cubre asiento negro Just



JUST/04G

esterno sedile Just grigio | Just grey outer seat | cubre asiento gris Just



VERSIONE PANCA/GIREVOLE | BENCH/SWIVEL VERSION | VERSION PARA BANCADA Y GIRATORIA



JUST/34

esterno sedile nero Just per panca | Just black outer seat for bench | cubre asiento negro para bancada Just



JUST/34/G

esterno sedile Just grigio per panca | Just grey outer seat for bench | cubre asiento gris para bancada Just



STRUTTURE | FRAMES | ESTRUCTURAS



JUST/05

fusto Just nero 4 piedi | Just black 4 legs frame | estructura 4 patas negra Just



JUST/06

fusto Just cromato 4 piedi | Just chromed 4 legs frame | estructura 4 patas cromada Just



JUST/07

fusto Just grigio 4 piedi | Just grey 4 legs frame | estructura 4 patas gris Just



JUST/08dx

fusto Just nero 4 piedi per bracciolo destro + tavoletta | Just black 4 legs frame for armrest right + writing tablet | estructura 4 patas negra Just por brazo derecho + pala



JUST/09dx

fusto Just cromato 4 piedi per bracciolo destro + tavoletta | Just chromed 4 legs frame for armrest right + writing tablet | estructura 4 patas cromada Just por brazo derecho + pala



JUST/10dx

fusto Just grigio 4 piedi per bracciolo destro + tavoletta | Just grey 4 legs frame for armrest right + writing tablet | estructura 4 patas gris Just por brazo derecho + pala



JUST/08sx

fusto Just nero 4 piedi per bracciolo sinistro + tavoletta | Just black 4 legs frame for armrest left + writing tablet | estructura 4 patas negra Just por brazo izquierdo + pala



JUST/09sx

fusto Just cromato 4 piedi per bracciolo sinistro + tavoletta | Just chromed 4 legs frame for armrest left + writing tablet | estructura 4 patas cromada Just por brazo izquierdo + pala



JUST/10sx

fusto Just grigio 4 piedi per bracciolo sinistro + tavoletta | Just grey 4 legs frame for armrest left + writing tablet | estructura 4 patas gris Just por brazo izquierdo + pala



JUST/11

fusto Just nero per ruote | Just black frame for castors | estructura negra Just por ruedas



JUST/12

fusto Just cromato per ruote | Just chromed frame for castors | estructura cromada Just por ruedas



JUST/13

fusto Just grigio per ruote | Just grey frame for castors | estructura gris Just por ruedas



STRUTTURA PER PANCA | BENCH FRAME | ESTRUCTURA PARA BANCADA



JUST/14

fusto verniciato nero per panca Just | Just black frame for bench | estructura para bancada negra Just



JUST/16

fusto verniciato grigio per panca Just | Just grey frame for bench | estructura para bancada gris Just



COMPONENTI MONTAGGIO | ASSEMBLING COMPONENTS | COMPONENTES PARA EL MONTAJE



JUST/18

set tappi neri per sottosedile Just | Just set black plugs for outer seat | set tapones negro por cubre asiento Just



JUST/18G

set tappi grigi per sottosedile Just | Just set grey plugs for outer seat | set tapones gris por cubre asiento Just



JUST/19

set coprisaldatura neri per 4 piedi senza braccioli | Just black set cover-welding for 4 legs frame without armrests | set cubre soldadura negro para estructura 4 patas Just sin brazos



JUST/19G

set coprisaldatura grigi per 4 piedi senza braccioli | Just grey set cover-welding for 4 legs frame without armrests | set cubre soldadura gris para estructura 4 patas Just sin brazos

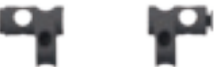

JUST/26

set coprisaldatura neri per fusto a 4 piedi + braccioli | Just set black cover-welding for 4 legs frame + armrest | set cubre soldadura negro x estructura 4 patas + brazos



JUST/26G

set coprisaldatura grigi per fusto a 4 piedi + braccioli | Just set grey cover-welding for 4 legs frame + armrest | set cubre soldadura gris x estructura 4 patas + brazos



VERSIONE PER PANCA | VERSIONS FOR BENCH | VERSION PARA BANCADA



JUST/30

coprisaldatura neri per panca | Just black cover-welding for bench | cubre soldadura negro para bancada Just



JUST/30G

coprisaldatura grigi per panca | Just grey cover-welding for bench | cubre soldadura gris para bancada Just



BRACCIOLI | ARMRESTS | BRAZOS



JUST/20

bracciolo destro Just in plastica | Just right black plastic armrest | brazo derecho de plastico negro Just



JUST/20-21

coppia braccioli Just in plastica neri | Just black plastic armrests | juego brazos negro de plastico Just



JUST/20-21G

coppia braccioli Just in plastica grigi | Just grey plastic armrests | juego brazos gris de plastico Just



JUST/21

bracciolo sinistro Just in plastica | Just left black plastic armrest | brazo izquierdo de plastico negro Just



JUST/22

bracciolo destro Just in alluminio nero con tavoletta | Just black right aluminium armrest + writing tablet | brazo derecho Just alluminio negro + pala



JUST/23

bracciolo sinistro Just in alluminio nero con tavoletta | Just black left aluminium armrest + writing tablet | brazo izquierdo Just alluminio gris + pala



RUOTE/PIEDINI | CASTORS/GLIDES | RUEDAS/PIE



RT09

ruota ø 50 p.11 nera | black castor ø 50 p.11 | rueda d.50 p.11 negra



COMPONENTI PANCA | BENCH COMPONENTS | COMPONENTES BANCADA



D05

adattatore nero per gp02 | black adapter for gp02 | adaptador negro para gp02



D05A

adattatore grigio per gp02a | grey adapter for gp02a | adaptador gris para gp02a



D06

adattatore per gp03n | adapter for gp03n | adaptador para gp03n



GP02

gamba panca in alluminio | polished aluminum bench leg | pata para bancada en aluminio lucido



GP02A

gamba panca in alluminio verniciata grigia | grey painted aluminum bench leg | pata para bancada en aluminio pintada gris



GP03N

gamba panca in alluminio verniciata nera fissa | black painted aluminum fixed bench leg | pata para bancada en aluminio fija pintada negra



TRA09

trave 80x40x1020 2 posti | beam 80x40x1020 2 seats | viga 80x40x1020 2 asientos



TRA10

trave 80x40x1600 3 posti | beam 80x40x1600 3 seats | viga 80x40x1600 3 asientos



TRA11

trave 80x40x2040 4 posti | beam 80x40x2040 4 seats | viga 80x40x2040 4 asientos





BRC23

bracciolo nero per panca | bench armrest for bench | brazo negro para bancada



VITI E TAPPI | SCREWS AND PLUGS | TORNILLOS Y TAPONES



JUST/44

tappo portaruota Just | Just castor support | soporte rueda Just



JUST/48

set tappi sottopiedi + viti per fusto Just | Just set glides + screws | set tapones + tornillos Just



ACCESSORI | ACCESSORIES | ACCESORIOS



JUST/31

aggancio unione Just nero | black Just linking device | enganche union Just negro

JUST/31G

aggancio unione Just grigio | grey Just linking device | enganche union Just gris





JEREMIAH FERRARESE

Nasce a Padova nel 1980 e si laurea in Architettura all'istituto IUAV di Venezia nel 2006. Nel 2005 inizia ad occuparsi di industrial design con particolare interesse al settore dell'arredo.

Born in Padua in 1980 and graduated in Architecture at IUAV Institute of Venice in 2006. In 2005 he began to work as an industrial designer with particular interest in the furniture industry.

Nace en Padua en el 1980 y se gradúa en arquitectura en el Instituto IUAV de Venecia en el 2006.

En el 2005 inicia su actividad en diseño industrial con particular interés en el sector del mobiliario.



PAOLO SCAGNELLATO

Nasce a Padova nel 1952 e si laurea in Architettura a Venezia nel 1976 con relatore l'Arch. Aldo Rossi. Dal 1977 esercita la libera professione.

Born in 1952 in Padua, in 1976 he obtains the degree in Architecture in Venice, with Arch. Aldo Rossi as reference-man. In 1977 he begins his individual activity.

Nace en Padua en el 1952 y se gradúa en arquitectura en Venecia en 1976 con el director de tesis Arq. Aldo Rossi. En 1977 inicia su actividad como profesional independiente.



cerantola 



CERANTOLA S.P.A.

Via Giorgione, 2 - 31037 Ramon di Loria (TV) ITALY
Tel. + 39 0423 755 013 r.a. - Fax + 39 0423 755 152
www.cerantola.com / info@cerantola.com